

# FASaD – fault and interruption handling in smart distribution systems

Northern ETIP-SNET Workshop

Helsinki

3.- 4. October 2018

# Fault and interruption handling in smart distribution systems (FASaD)

- Norwegian research and innovation project with funding from The Research Council of Norway, total budget of 1.9M Euro over 4 years
- Cooperation between SINTEF Energy Research and five Norwegian DSO's
  - Hafslund Nett (project owner), Skagerak Nett, Eidsiva Nett, Lyse Elnett, Istad Nett
- Demonstrate that use of new equipment decreases interruption duration, number of partial interruptions during localisation and interruption costs
  - Directional fault indicators
  - Remotely controlled disconnectors
  - Calculated distance to fault
  - Self-healing solutions

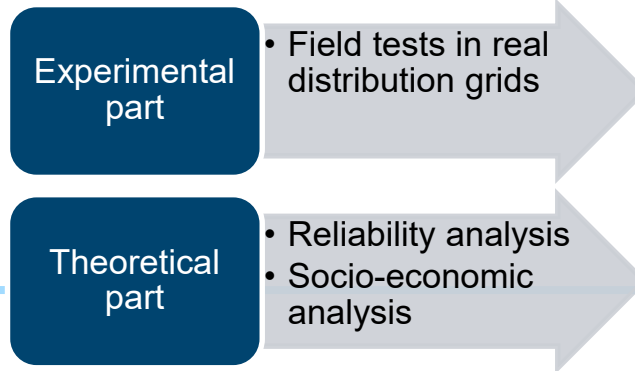

# Experimental part

# Testing and demonstration

- Testing and verification of functionality/accuracy of directional earth fault indicators (FPIs) in isolated and compensated MV-networks
- Estimation of fault location by short circuit calculations based on measured short currents in the transformer stations
- Self-healing in the MV-grid by use of intelligent automatic switching (based on sensor data, measurements and SCADA)

# Directional earth fault indication in compensated MV-networks

- Horstmann Sigma D+
- Horstmann Compass B
- Schneider Flair 22/23D
- Schneider F200C
- Siemens Sicam FCM
- NorTroll CableTroll 3610 / 600
- Cahors Sentinel D Underground
- ProTrol IPC 4012

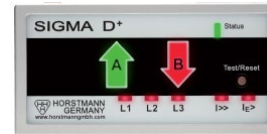

# Directional earth fault indication in compensated MV-networks

- NorTroll Linetroll 3500
- Cahors Sentinel D Overhead
- Schneider G200 Flite 116



Dragnetz Encore 61000 datalogger



# Detection principles covered by included FPIs

Detection principle	Algorithm(s)
Base frequency (50Hz)	Cos( $\varphi$ )-method Sin( $\varphi$ )-method
Harmonic components	«Half rectified currents»-method (Schneider)
Transients	Transient-method ICC-method (Schneider) Qu2- and Qui-method
Others	«Fast pulse»-method

# Test locations

## Hafslund Nett

- Minnesund
- Oslo
- Grålum

## Skagerak Nett

- Sande
- Langesund
- Myrene
- Frogner

## Eidsiva Nett

- Toten
- Våler

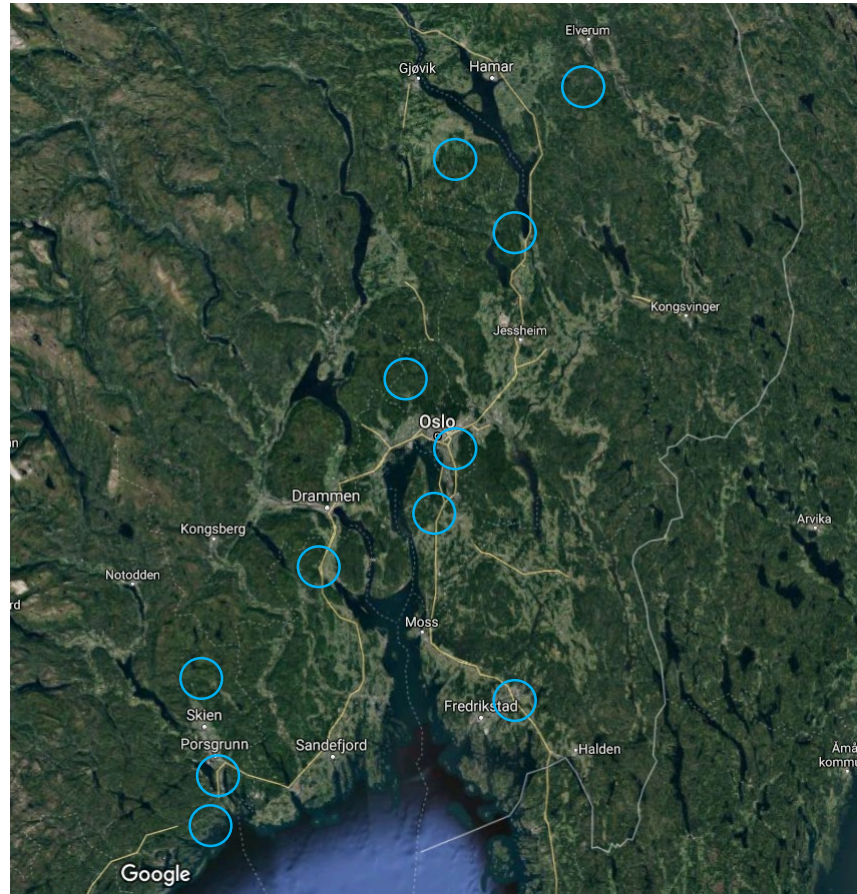



# Handling of faults and interruptions in a smart MV-grid

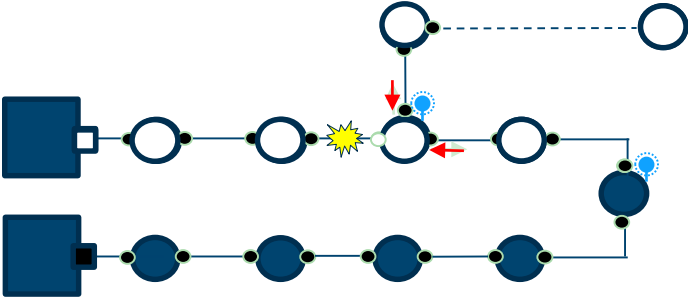

# Short circuit distance calculations

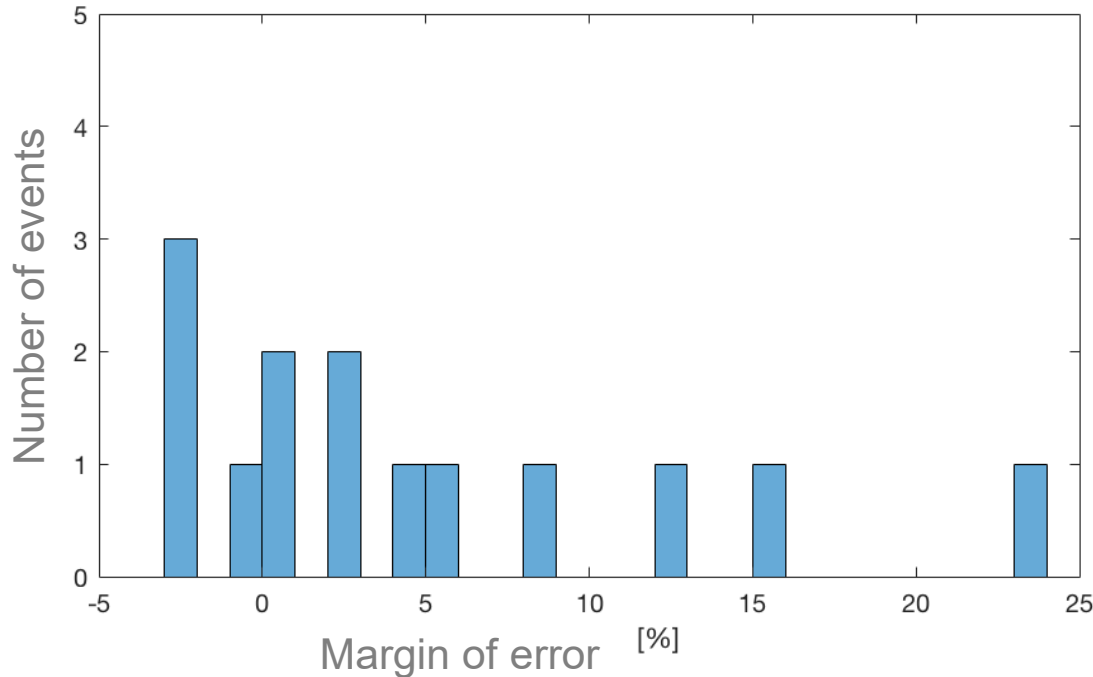

20 short circuits in Hafslund Nett's MV grid resulting in power outages, short circuit currents logged by the protection relays in the HV/MV substation

5 events was calculated to be «outside» of the grid (out of range), these are not included.

Average margin of error:

**6%** (~410 meters)

# Lessons learned from the testing and demonstration

- Setting up (parameters) and installing 10+ different models of FPIs is not «plug and play»
  - But some models are worse (less intuitive and/or needs more special tools) than others
- Models with on board display and configuration possibility seems to be easier to handle on a large scale
  - Because setting and installation errors will be done (and relocations), and changes/verifications are much easier to do in the field with these models
- Sometimes not enough space to install a sum-CT, resulting in the less ideal option of 3 single phase CTs
  - Sometimes even the single phase CTs are difficult to install because of *less ideal* design (only some vendors/models have this issue)
- Time...



# Our recommendations to manufacturers

- FPIs with possibility of parameterization on site with build in-display are preferable
- Compatibility of CTs between vendors/FPI models would be nice
  - May make it possible to replace/upgrade/change FPIs without (extra) planned outages
- Power supply in rural networks are not easy/cost efficient
  - Pole mounted models not requiring external power (even not battery replacement) are important for costs to come down and make large numbers of installed FPIs cost efficient in rural networks
- Please look into the integration of new communication technologies
  - Smart meter communication 870MHz (ip v6 LoWPAN), «5g» IoT, ???



# Deployment prospects for solutions

- Traditional RTUs and communication devices are driving costs for installing high numbers of FPIs
  - Also, the mere handling of a large number of RTUs and modems is complex
- The use of smart meter hardware and communication infrastructure for connecting FPIs to the control center makes it possible to decrease costs
  - Reserving traditional RTUs for remote controlled breakers
- Self healing functionality is starting to be «mainstream» in many new DMSs
  - Will probably be used in a greater extent than locally based logic, together with «traditional» RTUs and remote controlled disconnectors due to cost effectiveness and maintenance costs (but we are of course open to use both locally controlled systems and centrally controlled systems, whatever work best and is cost effective)



I/O  
Modbus  
PT100

# Theoretical part

# Reliability analysis methodology

Minimum cut set for load point  $L_1$ :

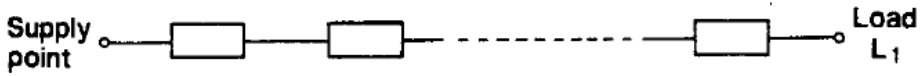

Which component give outage at the load point.

RELRAD approach

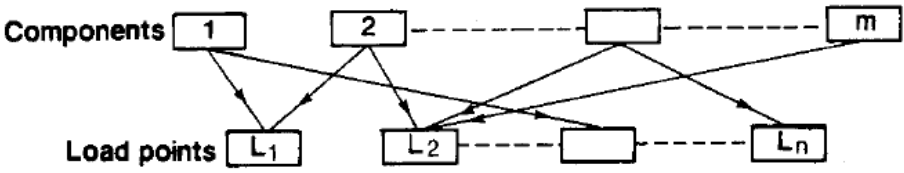

Which load points will have outage caused by the component.

Figure 2. Analytical techniques for radial systems.

**RELRAD**  
 RELiability in RADial  
 systems

# Smart fault and interruption handling

Effect of new equipment on reliability in terms of:

- Duration of fault localisation
- Number of partial interruptions during fault localisation
- Reduced interruption costs

→Need for updated methodology for reliability analyses



# Methodology

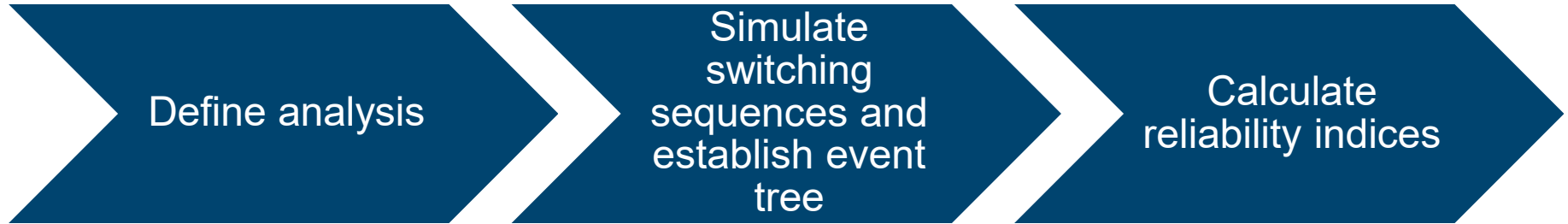

# Simulate switching sequences and establish event tree

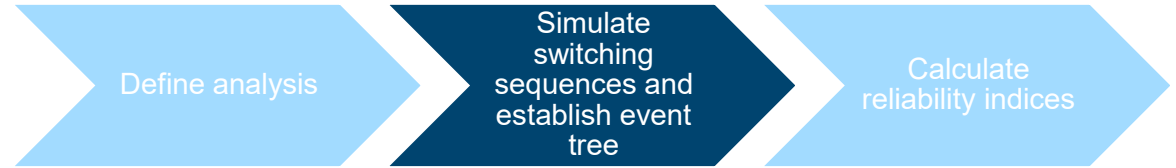

1. Primary fault occurs
2. Tripping of circuit breaker
3. Automatic reclosure
4. Remote switching
5. Manual switching (all switches available)
6. Manual reconnections

# Simulation of switching

- Criteria for selection of disconnecter during fault localisation:  
*The next disconnecter is chosen so that it minimizes the expected total hourly interruption cost in the affected area after test reclosure.*
- Based on
  - Fault probabilities
  - Average interruption cost per hour per delivery point
  - Fault probabilities for fault indicators

# Reliability indices

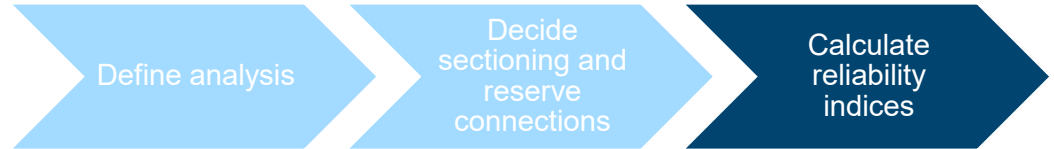

## Per delivery point:

- Annual number of interruptions (/yr)
- Annual number of partial interruptions (/yr)
- Annual interruption duration (min/yr)
- Average interruption duration (min/interruption)
- Annual energy not supplied (kWh/yr)
- Annual interrupted power (kW/yr)
- Annual interruption cost (NOK/yr)

## System indicators:

- Expected SAIFI
- Expected SAIDI

## Per interruption / primary fault:

- Annual duration of events

# Sample grid - calculations

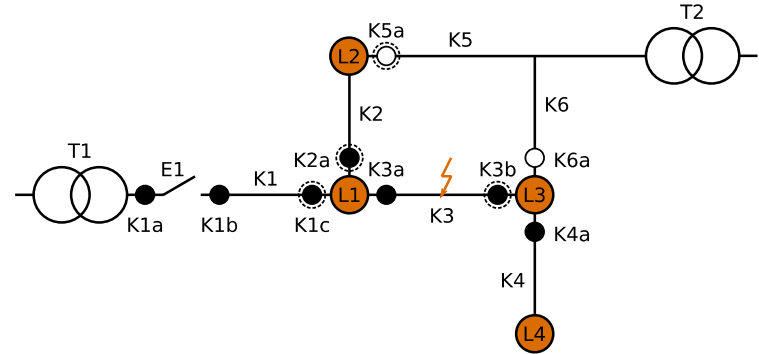

		All manual switches, no indicators	All manual switches, three indicators	Four remote switches, no indicators	Four remote switches, three indicators	All remote switches, three indicators
Annual interruption cost	NOK/year	631 561	552 028	347 841	342 808	297 081
Annual energy not supplied	kWh/year	10 060	8 282	3 811	3 689	2 557
Annual interrupted power	kW/year	11 200	11 200	11 200	11 200	11 200
Expected SAIDI	min/year	43,4	35,7	16,7	16,2	11,1
Expected SAIFI	interruptions/year	0,8	0,8	0,8	0,8	0,8
Annual duration of events	min/year	138,1	129,6	113,9	113,9	101,3

# Sample grid: CENS

Annual interruption cost NOK/year

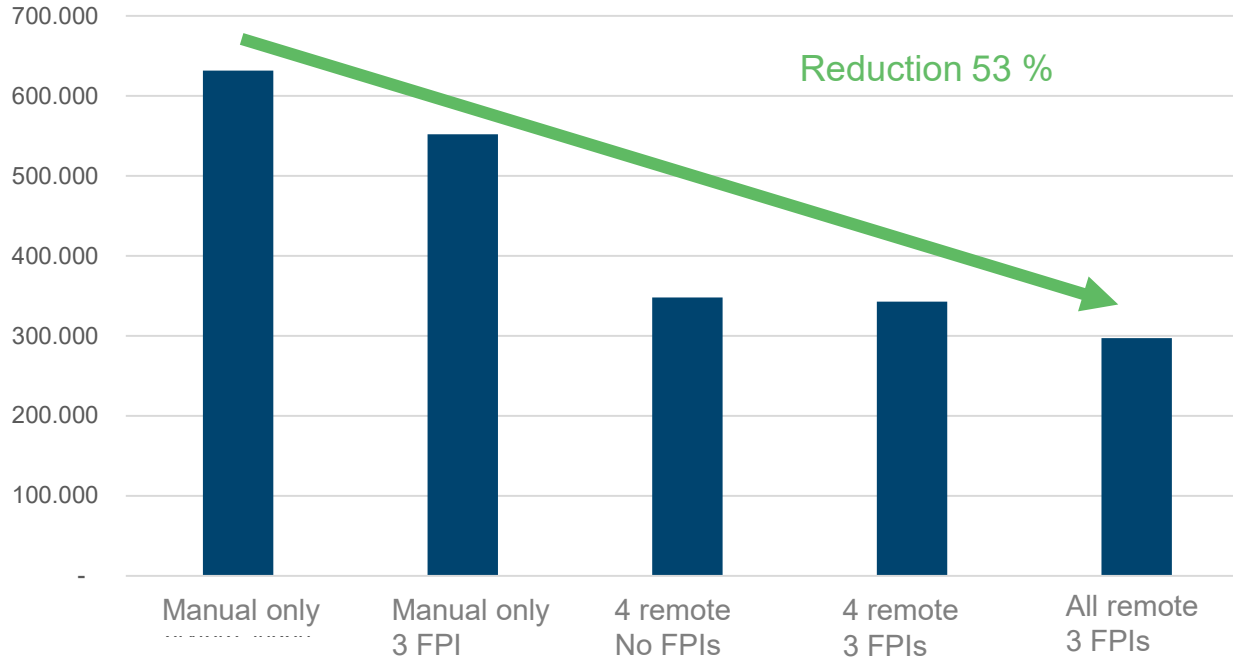

# Real grid

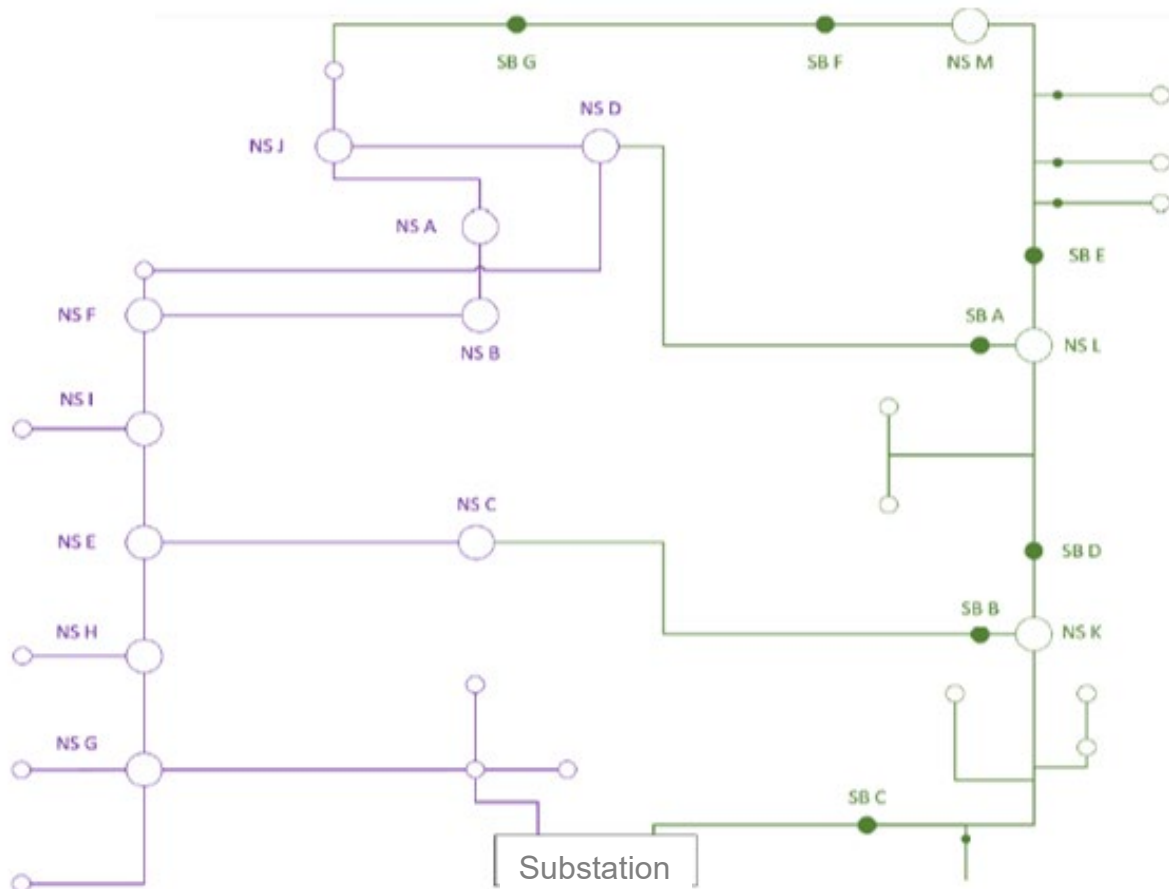

# Real grid (green): Reduction in CENS – several stations are upgraded

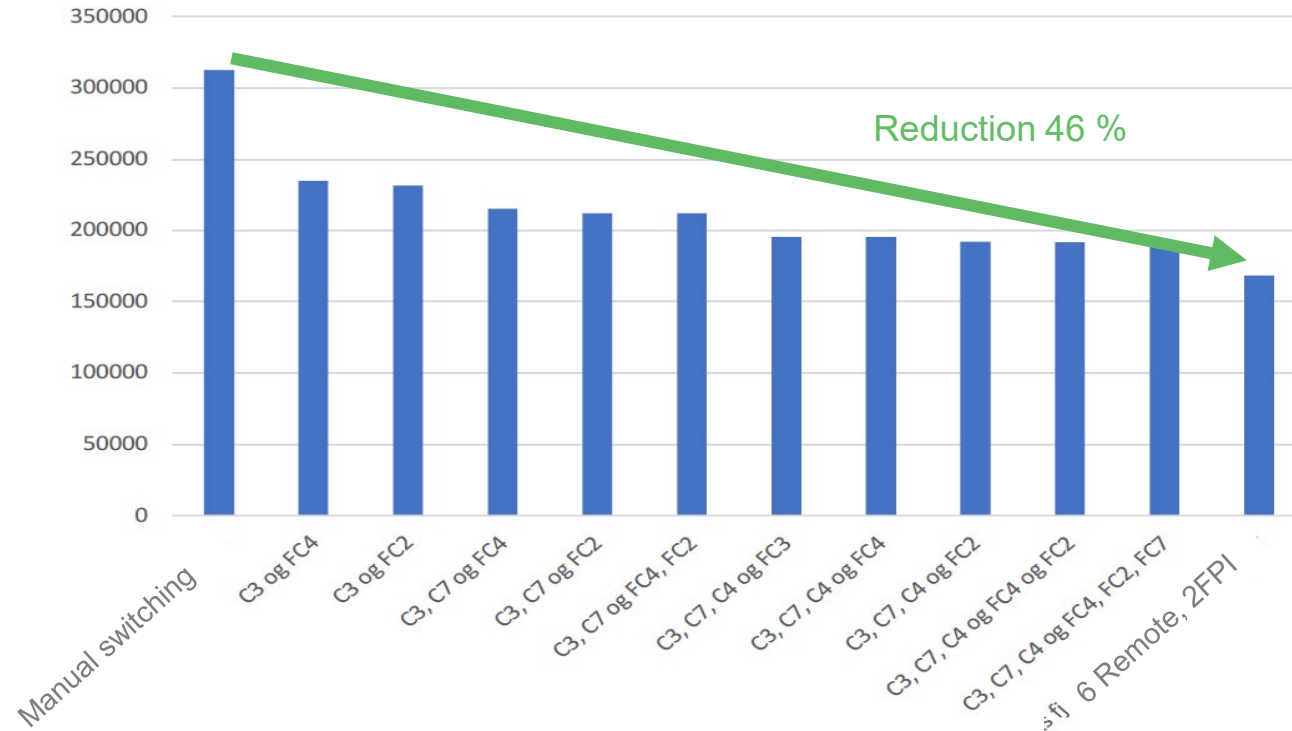



## Real grid (purple): Reduction in CENS – several stations are upgraded

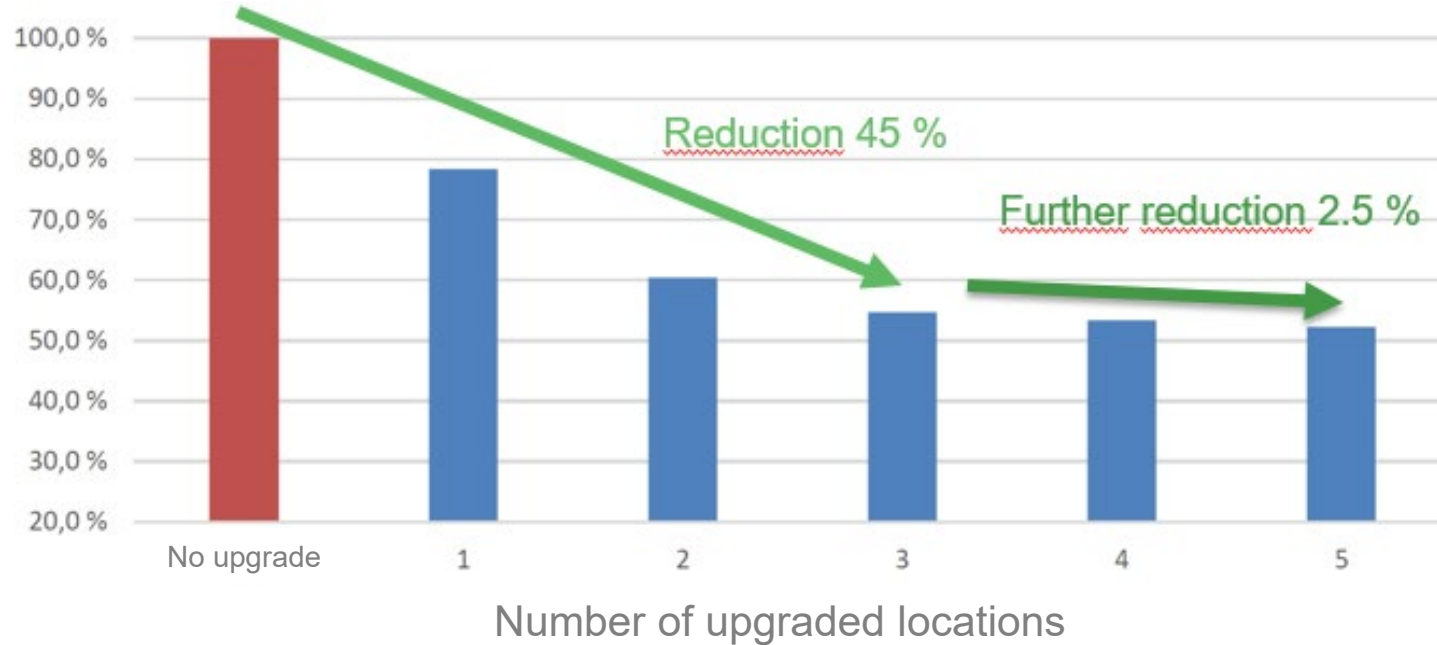

# Summing up

- Installing fault current sensors and remotely controlled disconnectors have a potential of reducing CENS by 30 - 50 %
- In Norway as a whole, this technology has a potential of reducing CENS in the MV (1-22kV) grid of ca. 125 MNOK per year (about 13 Million Euro)
- Important with demonstration, several lessons learned
- The demonstration shows a potential of faster restoration, reducing both frequency and duration of interruptions in the electricity supply

Need for future R&I and future testing:

- Need more testing of self healing solutions, takes long to implement and must “wait” for quite some time to have faults/events – 3-4 years can be a bit short to gather results





Kjell Anders Tutvedt  
Senior Engineer  
Hafslund Nett  
[kjell.anders.tutvedt@hafslund.no](mailto:kjell.anders.tutvedt@hafslund.no)